

Concealed Hinges

Grass Standard 100° Hinges

- Opening angle **100°**
- 0 mm, 8 mm or 15 mm crank
- Sprung
- Ø 35 mm cup
- Screw fixing, NT Quick fixing or dowel fixing cup
- Choice of slide on or click on arms
- Cup: Nickel-plated pressed steel, NT version die-cast
- Arm: Nickel-plated pressed steel
- **Mounting plates** for slide on and click on hinges shown on pages **22-24**
- **Hinge arm cover plates** are shown on page **25**
- Soft close compatible on sprung hinges

Screw fixing NT Quick fixing

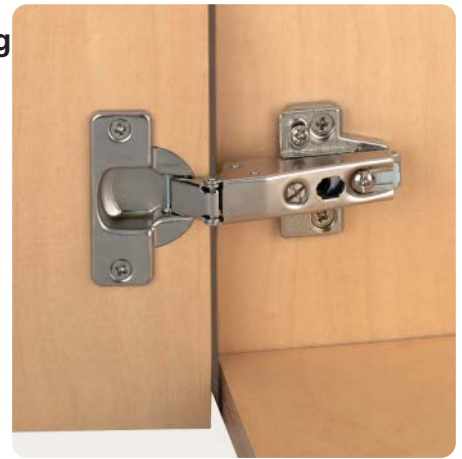
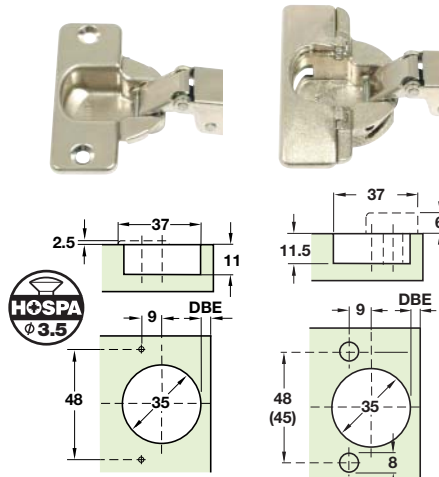

Dowel fixing

Will also fit 45 mm drilling pattern



Soft close clip on fitting for sprung hinges shown on page 25

Refer to page 12 for dowel fixing drilling pattern

Mounting screws

- Hospa chipboard screws, raised head, Ø 3.5 mm with cross slots
- Nickel-plated steel



Length	Cat. No.	Order qty
15 mm	015.55.639	1000
17 mm	015.55.648	1000
20 mm	015.55.657	1000

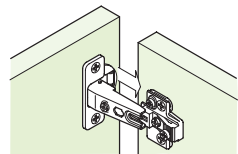

Slide on

100°

Crank	Screw fixing
0	323.40.500
8	323.40.501
15	323.40.502

Order qty: Multiples of 10 pcs

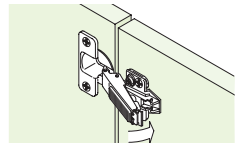

Click on

100°

Crank	Screw fixing	NT Quick fixing
0	322.15.540	322.56.630
8	322.15.541	322.56.631
15	322.15.542	322.56.632

Crank	Dowel fixing
0	322.15.590

Order qty: Multiples of 10 pcs

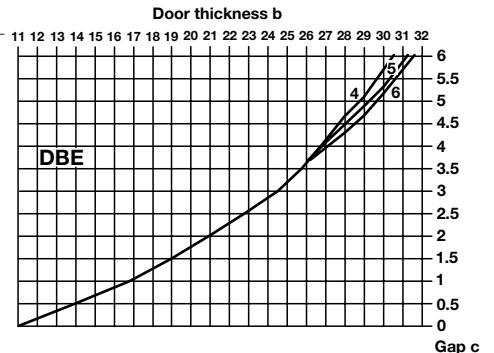
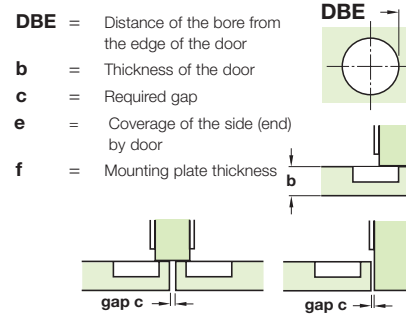

0 Crank

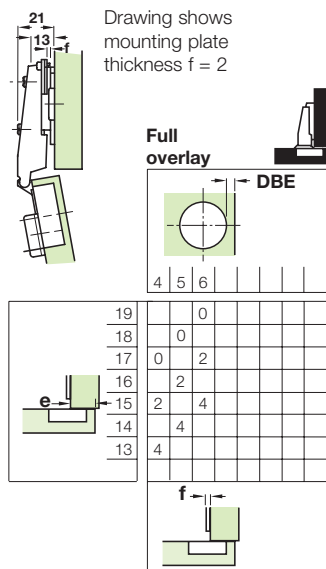

8 Crank

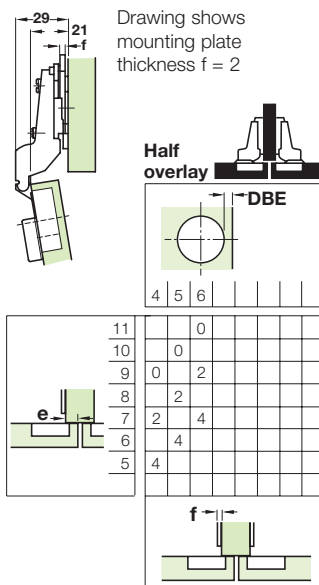

15 Crank

